

XGZP6830D PRESSURE SENSOR

FEATURES

- Wide Ranges: 0kPa ~ 100kPa~3000kPa(show in [Pressure Range Example](#))
- 1.8V ~ 3.3V Power Supply, low consumption
- Absolute Pressure Type
- For Non-corrosive Gas or Air or Liquid
- Calibrated Digital Signal(I2C Interface)
- Current Consumption:<80uA(single measurement at 128 OSR)
- Standby Current:<100nA (25°C)
- Temp. Compensated
- Temperature Accuracy:±1°C

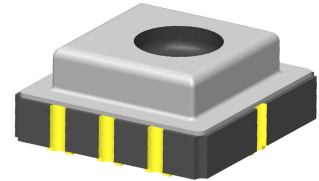

APPLICATIONS

- Air pump, Inflator pump, White goods(e.g.washer), Heating, Ventilation, Air conditioning, Fire extinguisher, Filter detection, Industrial controls.
- Medical gas control system, Hospital beds, Massage device, Oil pressure, Engine control/manifold absolute pressure (MAP), Green gas(LPG and CNG) control and measurement, Tire pressure meter.
- Weather station and weather reporting device barometers, Altimeter, Drone, Sport and leisure equipment, Vacuum measurement, pneumatic device, GPS, Navigation.

INTRODUCTION

XGZP6830D is a perfect silicon pressure sensor offering a ratiometric I2C interface for reading pressure over the specified full scale pressure span.

The XGZP6830D incorporates a silicon piezoresistive pressure sensor die and an interior Application Specific Integrated Circuit(ASIC) in a small COB package with silicon gel covering.

The XGZP6830D is fully calibrated and temperature compensated for offset, sensitivity, temperature and non-linearity, so XGZP6830D pressure sensor satisfy the prefect repeatability, linearity, stability and sensibility, which can be applied directly in home appliances, consumer electronic, industry, automotive and other pneumatic devices etc.

XGZP6830D pressure sensor is for high volume application at an affordable cost but perfect performance.

Customized calibrations (e.g.pressure range etc.) are available

PERFORMANCE PARAMETER

Unless otherwise specified, measurements were taken with a temperature of 25±1°C and humidity ranging from 25% ~ 85%RH.

Item	Data	Unit	Remark
Available Pressure Range ¹	0 ~ 100...3000	kPa	Customization acceptable
Power Supply ²	1.8~3.3V	Vdc	
Max. Excitation Current	3	mA	
ADC Resolution ³	24	Bit	
SDA/SCL pull up resistor	2.2	Kohm	
ESD HBM	4000	V	
Total Accuracy ⁴	±2.5	%Span	Customization acceptable
Long Term Stability ⁵	±0.5	%Span	
Over Pressure ⁶	1.5X	Rated	
Burst Pressure ⁷	2X	Rated	
Compensation Temp. ⁸	0 ~ 60/32 ~ 140	°C/°F	Customization acceptable
Operating Temp. ⁹	-20 ~ 100/-4 ~ 212	°C/°F	
Storage Temp.	-30 ~ 125/-22 ~ 257	°C/°F	
Response Time ¹⁰	2.5	mS	

1 **Pressure Range(Operating pressure)**: The available pressure range including various span, not a specific pressure range.

2 **Power supply**: The default test voltage value: 3.3V, available power supply voltage range:1.8~3.3V

3 **ADC Resolution**: The ADC resolution is defined as the smallest incremental voltage that can be recognized and thus causes a change in the digital output.

4 **Total Accuracy**: The max. deviation in output from ideal transfer function at any pressure or temperature over the specified ranges, units are in percent of full scale span (%FSS), which mainly consists of: Offset and Span Shift;Linearity(Non-linearity); Repeatability; Pressure Hsteresis ; TcOffset and TcSpan.

4.1. The accuracy in table is the typical output accuracy. The accuracy is not identical according to different specified pressure range. Contact factory for more information or for higher accuracy requirement(e.g ±1%Span) if need.

4.2 Non-linearity(Linearity): the deviation of measured output from "Best Straight Line" through three points (Offset pressure, FS pressure and ½ FS pressure)at constant temperature.

4.3 Repeatability: the deviation of measured output when the same pressure is applied continuously, with pressure approaching from the same direction within the specified operating pressure range,under the same operating conditions.

4.4 Pressure Hysteresis: the deviation of measured output at any pressure within the specified range, when this pressure is applied continuously, with pressure approaching from opposite directions within the specified operating pressure range, under the same operating conditions.

4.5 TcOffset (TCO:Temp. Coefficient of Offset): the deviation of measured output with minimum rated pressure applied, over the temperature range of 0° to 60°C, relative to 25°C.

4.6 TcSpan (TCS:Temp. Coefficient of Span): the deviation of measured output over the temperature range of 0° to 60°C, relative to 25°C.

5. **Long Term Stability**: the sensor's output deviation when subjected to 1000 hours pressure test.

6. **Over Pressure** (Proof pressure): the maximum pressure which may be applied without causing durable shifts of the electrical parameters of the sensing element and remain the specification once pressure is returned to the operating pressure range.
7. **Burst Pressure**: the maximum pressure which may be applied without causing damage to the sensing die or leaks; The sensor should not be expected to recover function after exposure to any pressure beyond the burst pressure.
8. **Compensated Temperature**: the temperature range over which the sensor have an output proportional to pressure within the specified performance limits.
9. **Operating Temperature** (or Ambient Temperature): the temperature range over which the sensor have an output proportional to pressure but may not remain within the specified performance limits.
10. **Response Time**: it is defined as the time for the incremental change in the output from 10% to 90% of its final value when subjected to a specified step change in pressure.

BLOCK DIAGRAM

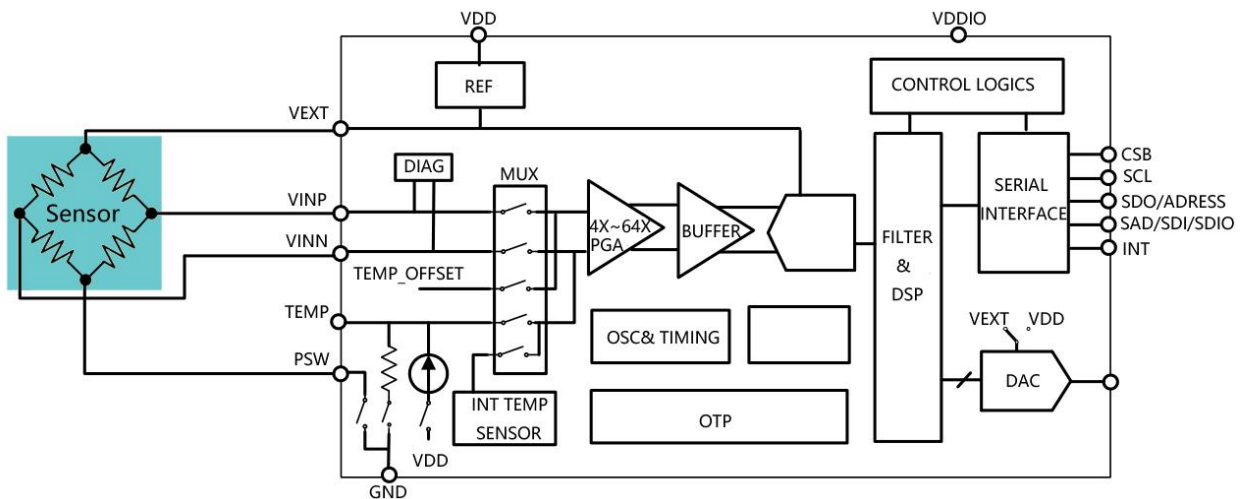

PERFORMANCE PARAMETER

Unless otherwise specified, measurements were taken with a temperature of $25 \pm 1^\circ\text{C}$ and humidity ranging from 25% ~ 85%RH.

Parameter	Conditions	Min	Typ	Max	Units
Temp.Measure Range	Interior temp.sensor	-40		150	$^\circ\text{C}$
Absolute Pressure Accuracy		-1		1	hPa
Relative Pressure Accuracy		-0.12		0.12	hPa
Temp. Measure Accuracy		-1		1	$^\circ\text{C}$
Over Pressure			2x		Rated
Working Temp.		-40		85	$^\circ\text{C}$
CompensatedTemp.		0		60	$^\circ\text{C}$

ELECTRICAL CHARACTERISTICS(ASIC)

Parameter	Conditions	Min	Typ	Max	Units	
	At VDD=2V	32			dB	
Average current during 1Hz conversion rate measurement	OSR_P	Oversampling rate 128x		80		μA
		Oversampling rate 64x		42		
		Oversampling rate 32x		23		
		Oversampling rate 16x		13		
		Oversampling rate 8x		8		
		Oversampling rate 3x		6		
		Oversampling rate 2x		4		
Peak Current			0.3		mA	
Standby Current	Standby current in sleep state at 25°C		50	250	nA	
Single measurement time (Including external bridge and temperature measurement time, the OSR of temperature measurement is 1024x)	OSR_P	Oversampling rate 128x		203		ms
		Oversampling rate 64x		105		
		Oversampling rate 32x		56		
		Oversampling rate 16x		31		
		Oversampling rate 8x		19		
		Oversampling rate 4x		13		
		Oversampling rate 2x		10		
ADC Conversion rate	OSR as 2x ~ 128x	20		1350	Hz	
I2C Clock frequency				3.4	MHz	
Temperature resolution			0.003		K/LSB	
Start Time	VDD to the time when the interface communication starts			1	ms	
	VDD to the time when the measurement starts			2.5	ms	
Wake up Time	Sleep status to the time when the interface communication starts			0.5	ms	
	Sleep status to the time when the measurement starts			2	2	

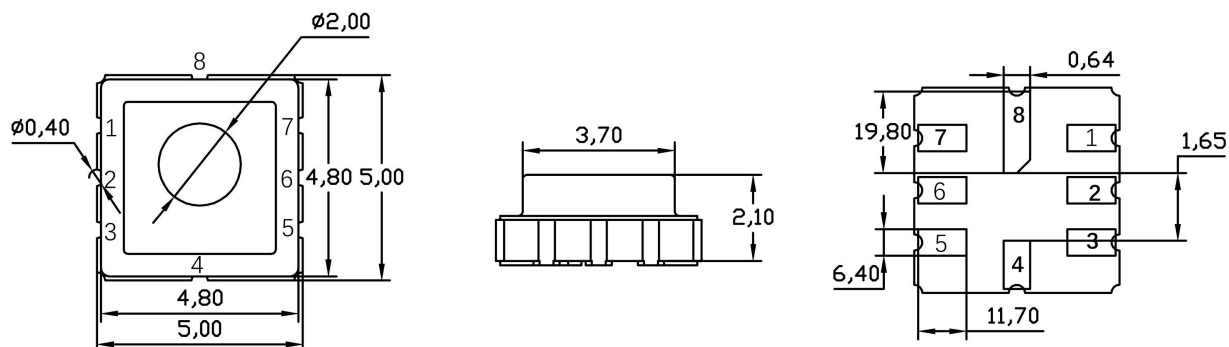
DIMENSION (Unit:mm)

ELECTRIC CONNECTION

1	2	3	6	4、5、7、8
GND	SCL	SDA	VDD	NC

NAME	FUNCTION
NC	Do not connect to external circuitry or ground
VDD	Voltage supply
SDA	Data signal(Send& Receive)
SCL	The clock signal
GND	Ground

CIRCUIT DIAGRAM

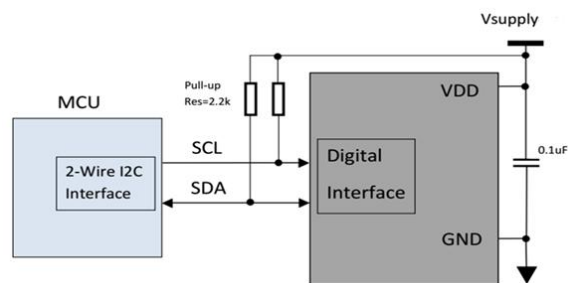

CROSS SECTION

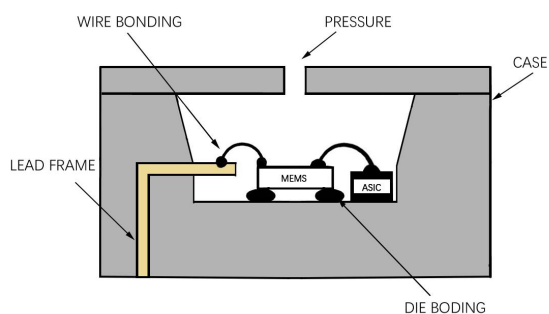

FOOTPRINT(REFERENCE)

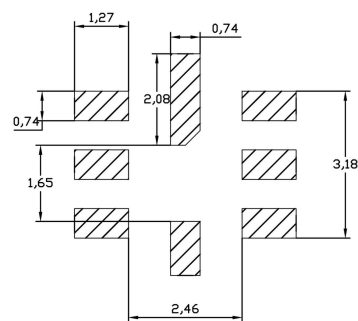

Notes:

- 1.Implement ESD protection during whole soldering and assembly process.
- 2.Overload voltage(max.6.5Vdc) or current(max.5mA) may burn the ASIC and cause the sensor fail throughly.
- 3.More details about soldering and storage etc., refer to [Overall notes](#).

ORDER GUIDE

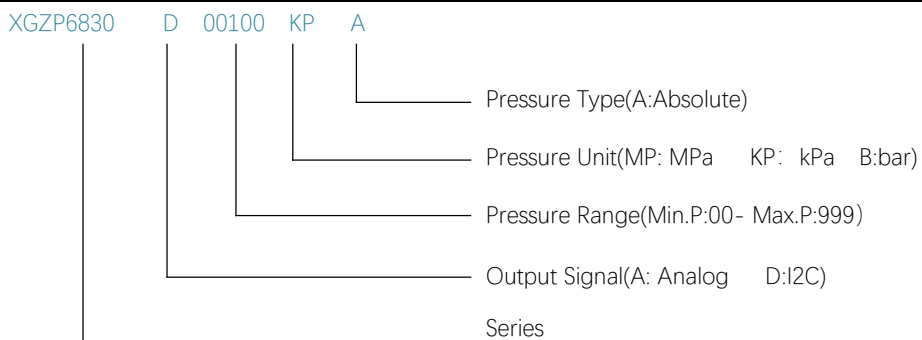

Note: Custom requirement or parameter, please consult CFsensor and comment custom code herewith Part number.

PRESSURE RANGE EXAMPLE

Notes: 1. Unit conversion: $1000\text{hPa}=1000\text{mbar}\approx 750\text{mmHg}\approx 100\text{kPa}\approx 14.5\text{PSI}\approx 10\text{mH}_2\text{O}\approx 1\text{bar}=0.1\text{MPa}$;
 2. Available for more custom pressure range e.g. 15 ~ 115kPa, 75 ~ 325kPa etc.,

Pressure Range (kPa)	Pressure Range (by other units)	Part Number
100 ~ 3000kPa	1 ~ 30bar /0.1 to 1MPa	XGZP6830D01-030BA
30 ~ 110kPa	0.3 ~ 1.1bar	XGZP6830D03-110KPA
Other higher pressure range or custom pressure span eg 260~1260hPa, consult CFSensor		

I2C INTERFACE

The I2C bus uses SCL and SDA as signal lines, both of which are connected to VDD through pull-up resistors (typically 2.2K) and remain high level when not communicating.

The sensor is calibrated at the factory. Sending the 0xAC command to get the calibrated data..

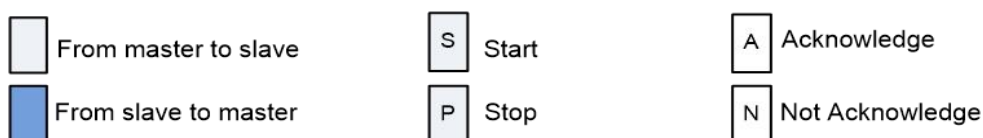

Write Command



0xF0 means that the default 7bits I2C sensor slave device address is 0x78, and the last 1bit is 0 means that the master device MCU writes to the slave device. 0xAC is the command word to start the slave device sensor to perform a measurement. (The write address is $0X78\ll 1+0=0XF0$, and the read address is $0X78\ll 1+1=0XF1$)

Read Command



After sending the write command, need to wait for a while till measurement finish from the slave device sensor, and then send the read command to read the measurement data. Then sending the 0XF1 command to determine whether the sensor data acquisition has been completed

The waiting time depends on the settings of [13:11] Pressure Oversampling Rate of OTP (Address: 0x14) and [15:14] Temperature Oversampling Rate of OTP (Address: 0x14). The waiting time is =Tp+Tt.

Pressure Oversampling Rate and Measurement Time Comparison Table

OSR_Pressure[13:11] (Banary)	OSR	Measurement Time Tp(ms)
000	32768	203
001	16384	105
010	8192	56
011	4096	31
100	2048	19
101	1024	13
110	512	10

Temperature Oversampling Rate and Measurement Time Comparison Table

OSR Temperature[15:14] (Banary)	OSR	Measurement Time Tt(ms)
00	2048	19
01	4096	31
10	8192	56
11	16384	105

Read Pressure Value

The read calibration data consists of 6 bytes, which are 1-byte status word, 3-byte pressure calibration value, and 2-byte temperature calibration value.

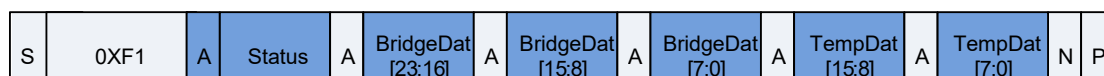

Table: Status of Bits

Bit	Significancy	Description
Bit7	Reserved	Constant 0
Bit6	Power indication	1: Power on; 0: Power off
Bit5	Busy indication	1: Busy, the device is measuring pressure and temperature and the results are not ready yet. New I2C command will not be proceeded; 0: Idle, the recent I2C command has been executed and the data to be read is ready
Bit4	Reserved	Constant 0
Bit3	Mode Status	NOR mode;1 CMD mode
Bit2	Memory integrity /error flag	0 Indicates that the OTP memory data integrity test (CRC) passed; 1 Indicates that the OTP memory data integrity test (CRC) failed. The data integrity test is only calculated once during the power-on process (POR), so the new CRC value written only can be used after the next POR.
Bit1	Reserved	Constant 0
Bit0	Reserved	Constant 0

Sleep Standby

After the sensor completes the measurement, it enters the sleep standby state, and the standby power consumption is 0.1uA.

I2C Command

Command(byte)	Return	Description	NOR Mode	CMD Mode
0x00~0x1F	16-bit data	Read data in the OTP that address matching command	Support	Support
0x40~0x5F Followed command byte: 0x0000 ~0xFFFF	—	Write data to OTP; Address is Command value subtract 0x40 (Address is 0x00 to 0x1F)	Support	Support
0xA0~0xA7 Followed command byte: 0xFFFF	24-bit raw data Get_Raw	Get_Raw Conduct one measurement, and write the raw ADC data to registers. See table 6-3 for further interpretation	Support	Support
0xA8	24-bit raw data Get_Raw	Start_NOM Quit CMD mode, enter NOR mode	No-Support	Support
0xA9	—	Start_CM Quit NOR mode, enter CMD mode	Support	No-Support
0xAA	—	Write_ChecksumC If CRC values are not wrote to OTP, the command check data in OTP register and writes CRC values to OTP	Support	Support
0xAC	24-bit compensated bridge data and 16-bit compensated temperature data	Get_Cal Measure based on OTP settings(AZBM, BM,AZTM and TM), write compensated bridge and temperature data to I2C interface	Support	Support
0xB0~0xBF	24-bit compensated bridge data and 16-bit compensated temperature data	Get_Cal_S and Get_Cal are the same except that Get_Cal measures based on OTP defined OSR and Get_Cal_S measures based on command defined OSR, see following table	Support	Support

Get_Cal_S Command

Command 0xBX(HEX)	Function	Detail
X [3] Bit	OSR_T, ADC OSR of temperature measurement	0: 4x OSR 1: 8x OSR
X [2:0] Bit	OSR_P, ADC OSR of pressure measurement	000: 128x OSR 100: 8x OSR 001: 64x OSR 101: 4x OSR 010: 32x OSR 110: 2x OSR 011: 16x OSR 000: 1x OSR

For example, to set the temperature ADC to 4x oversampling and the piezoelectric panel ADC to 1x oversampling, the command format is 0xB7, Just replace 0xAC with 0xB7

I2C TIME DIAGRAM

The I2C interface protocol has special bus signal conditions. Start (S), stop (P) and binary data conditions are shown below. At start condition, SCL is high and SDA has a falling edge. Then the slave address is sent. After the 7 address bits, the direction control bit R/W selects the read or write operation. When a slave device recognizes that it is being addressed, it should acknowledge by pulling SDA low in the ninth SCL (ACK) cycle. At stop condition, SCL is also high, but SDA has a rising edge. Data must be held stable at SDA when SCL is high. Data can change value at SDA only when SCL is low.

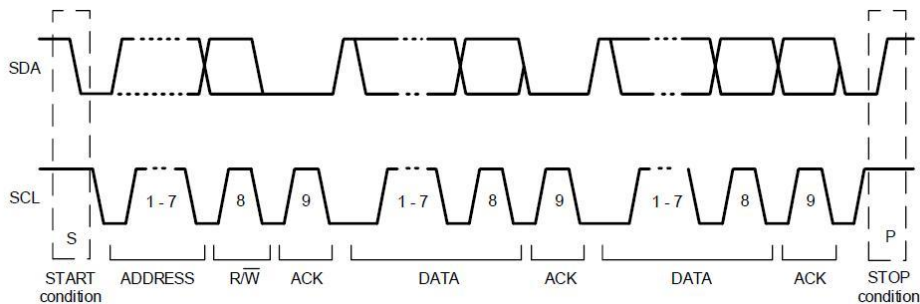

- **Pressure conversion example:**

After reading the calibration data, need to convert simply the unsigned number in the form of AD value..

To facilitate understanding, assuming that the calibration data read is: 0x04, 0x9B, 0xB0, 0xC5.

0x04 is the status, and Bit5 is 1 indicating that the I2C is busy last time, and it needs to wait for a period of time. If Bit5 is 0, it indicates that the device is not busy and data can be read. For a detailed description of each bit of the status word, see above table

The three bytes of 0x9B, 0xB0, and 0xC5 are bridge calibration values.

The pressure calibration value is converted as follows:

Assuming that the range used in this calculation and calibration is 20Kpa-700Kpa, the corresponding AD output is 2852126~14260633(17%AD~85%AD).

Then convert 0x9B, 0xB0, and 0xC5 into decimal numbers, assuming it is 4091970,. According to the formula:

pressure_kpa = ((P_{MAX}-P_{MIN})/(D_{MAX}-D_{MIN})*(D_{test}-D_{MIN})+P_{MIN}), actual pressure value=(700-20) / (14260633-2852126) * (4091970-2852126) + 20 = 94 Kpa

The temperature calibration value is converted as follows:

Converting 0x56, 0xAA to a decimal number is 22186. Since the read calibration data is expressed as a percentage, this percentage is numerically equal to the ratio of the decimal number we converted to the maximum value of 16bits unsigned number (65535, full AD value of whole temperature range from -40°C to 150 °C). Therefore, the following calculations can be made when converting percentages: 22186/65536*100%=33.85%

The temperature calibration range is specified as -40°C—150°C, so the calibration value=(150-(-40))*33.85%—40=24.32°C

PACKING INFORMATION

Tape&Reel(unit:mm)

Standard Quantity/Reel: 3,000 pcs

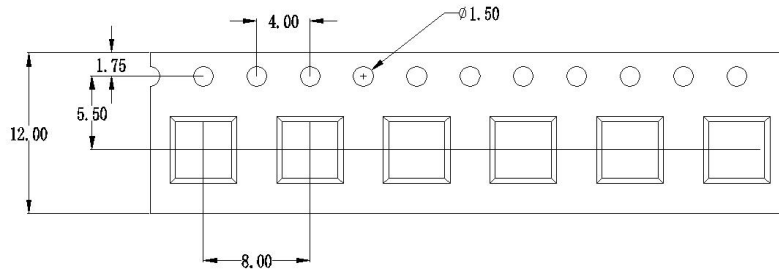

Tape

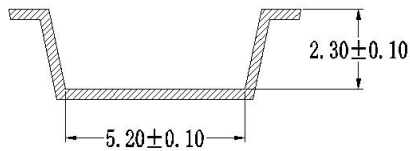

A-A

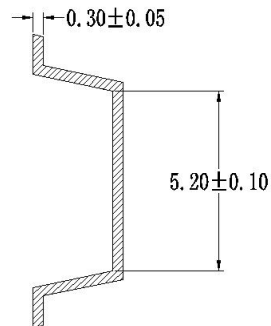

B-B

Side view

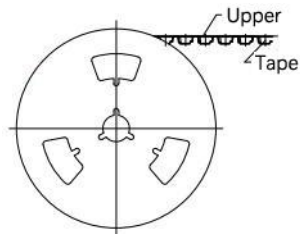

330*100*12



Reel

Note: The packing method for less quantity than Standard Quantity/Reel may be not quite same with above.

OVERALL NOTES

Unless otherwise specified, following notes are general attention or presentation for all products from CFSensor.

Mounting

The following steps is for transmitting the air pressure to sensor after sensor soldering on PCB.

- ▼ For some sensors that come with inlet tube, select the flexible pipe to suit the pressure inlet that is firm enough to prevent the pressure leaks.
- ▼ Atmosphere hole (for Gauge type sensors) and Inlet pipe/hole can't be blocked with gel or glue etc...
- ▼ Avoiding excessive external force operation

Soldering

Due to its small size, the thermal capacity of the pressure sensor is low. Therefore, take steps to minimize the effects of external heat. Damage and changes to characteristics may occur due to heat deformation. Use a non-corrosive resin type of flux. Since the pressure sensor is exposed to the atmosphere, do not allow flux to enter inside.

- ▼ Manual soldering
 - Raise the temperature of the soldering tip between 260 and 300°C/500 and 572°F (30 W) and solder within 5 seconds.
 - The sensor output may vary if the load is applied on the terminal during soldering.
 - Keep the soldering tip clean.
- ▼ DIP soldering (DIP Terminal)
 - Keep the temperature of the DIP solder tank below 260°C/500 and solder within 5 seconds.
 - To avoid heat deformation, do not perform DIP soldering when mounting on the PCB which has a small thermal capacity.
- ▼ Reflow soldering (SMD Terminal)
 - The recommended reflow temperature profile conditions are given below.

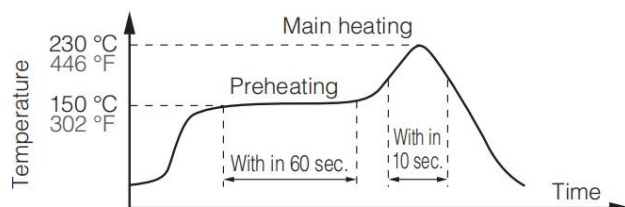

- Self alignment may not always work as expected, therefore, please carefully note the position of the terminals and pattern.
- The temperature of the profile is assumed to be a value measured with the PCB of the terminal neighborhood.
- Please evaluate solderability under the actual mounting conditions since welding and deformation of the pressure inlet port may occur due to heat stress depending on equipments or conditions.
- ▼ Rework soldering
 - Complete rework at a time.
 - Use a flattened soldering tip when performing rework on the solder bridge. Do not add the flux.
 - Keep the soldering tip below the temperature described in the specifications.
- ▼ Avoid drop and rough handling as excessive force may deform the terminal and damage soldering characteristics.
- ▼ Keep the circuit board warpage within 0.05 mm of the full width of the sensor.
- ▼ After soldering, do not apply stress on the soldered part when cutting or bending the circuit board.
- ▼ Prevent human hands or metal pieces from contacting with the sensor terminal. Such contact may cause anomalous outlets as the terminal is exposed to the atmosphere.

▼ After soldering, prevent chemical agents from adhering to the sensor when applying coating to avoid insulation deterioration of the circuit board.

Connecting

▼ Correctly wire as in the connection diagram. Reverse connection may damage the product and degrade the performance.

▼ Do not use idle terminals(N/C) to prevent damages to the sensor.

Cleaning

▼ Since the pressure sensor is exposed to the atmosphere, do not allow cleaning fluid to enter inside from atmosphere hole (for Gauge type sensors) and inlet pipe.

▼ Avoid ultrasonic cleaning since this may cause breaks or disconnections in the wiring.

Environment

▼ Please avoid using or storing the pressure sensor in a place exposed to corrosive gases (such as the gases given off by organic solvents, sulfurous acid gas, hydrogen sulfides, etc.) which will adversely affect the performance of the pressure sensor chip.

▼ Since this pressure sensor itself does not have a water-proof construction(even available media can be liquid), please do not use the sensor in a location where it may be sprayed with water, etc.

▼ Avoid using the pressure sensors in an environment where condensation may form. Furthermore, its output may fluctuate if any moisture adhering to it freezes.

▼ The pressure sensor is constructed in such a way that its output will fluctuate when it is exposed to light. Especially when pressure is to be applied by means of a transparent tube, take steps to prevent the pressure sensor chip from being exposed to light.

▼ Avoid using pressure sensor where it will be susceptible to ultrasonic or other high-frequency vibration.

▼ Keeping the sensors sealed in static shielding bags with an oxygen-free condition and use the sensor as soon as possible once unfold the package, because the sensors' PINs may be oxidated a bit under atmosphere environment(slight oxidation wouldn't affect soldering and performance)

More Precautions

▼ That using the wrong pressure range or mounting method may result in accidents.

▼ The only direct pressure medium you can use is non-corrosive gas or air as illuminated above(Note: some sensors are compatible with liquid media). The use of other media, in particular, corrosive gases and liquid (organic solvent based, sulfurous acid based, and hydrogen sulfide based, etc.) or contains foreign substances will cause malfunction and damage. Please do not use them and check with CFSensor.

▼ The pressure sensor is positioned inside the pressure inlet. Never poke wires or other foreign matter through the pressure inlet since they may damage the sensor or block the inlet. Avoid use when the atmospheric pressure inlet(only for Gauge type pressure sensor) is blocked.

▼ Use an operating pressure which is within the rated pressure range. Using a pressure beyond this range may cause damage.

▼ Since static charge can damage the pressure sensor, bear in mind the following handling precautions.

⊙ When storing the pressure sensor, use a conductive material to short the pins or wrap the entire sensor in aluminum foil. Common plastic containers should not be used to store or transport the sensor since they readily become charged.

⊙ When using the pressure sensor, all the charged articles on the bench surface and the work personnel should be

grounded so that any ambient static will be safely discharged.

▼Based on the pressure involved, give due consideration to the securing of the pressure sensor.

【 SAFETY NOTES 】

Using these sensors products may malfunction due to external interference and surges, therefore, please confirm the performance and quality in actual use. Just in case, please make a safety design on the device (fuse, circuit breaker, such as the installation of protection circuits, multiple devices, etc.), so it would not harm life, body, property, etc even a malfunction occurs. To prevent injuries and accidents, please be sure to observe the following items:

- The driving current and voltage should be used below the rated value.
- Please follow the terminal connection diagram for wiring. Especially for the reverse connection of the power supply, it will cause an accident due to circuit damage such as heat, smoke, fire, etc.
- In order to ensure safety, especially for important uses, please be sure to consider double safety circuit configuration.
- Do not apply pressure above the maximum applied pressure. In addition, please be careful not to mix foreign matter into the pressure medium. Otherwise, the sensor will be discarded, or the media will blow out and cause an accident.
- Be careful when fixing the product and connecting the pressure inlet. Otherwise, accidents may occur due to sensor scattering and the blowing out of the media.
- If the sensor come with sharp PIN, please be careful not to hurt your body when using it.

【 WARRANTY 】

The information in this sheet has been carefully reviewed and is believed to be accurate; however, no responsibility is assumed for inaccuracies. Furthermore, this information does not convey to the purchaser of such devices any license under the patent rights to the manufacturer. CFSensor reserves the right to make changes without further notice to any product herein. CFSensor makes no warranty, representation or guarantee regarding the suitability of its product for any particular purpose, nor does CFSensor assume any liability arising out of the application or use of any product or circuit and specifically disclaims any and all liability, including without limitation consequential or incidental damages. Typical parameters can and do vary in different applications. All operating parameters must be validated for each customer application by customer's technical experts. CFSensor does not convey any license under its patent rights nor the rights of others.

【 CONTACT 】

CFSensor

22F/14Bldg High-Tech Park High-Tech Area Wuhu P.R.C.241000

Tel/Fax: +86 18226771331 Email: INFO@CFSensor.com

North America || Europe || Southeast Asia || Middle East || Latin America

IIC Example Code (C51 Language)

```
#include <reg52.h>
#include <stdio.h>
#include <math.h>

#define DELAY_TIME 20

#define PMIN 0 // The minimum range pressure value for example 20Kpa 传感器最低量程
#define PMAX 700.0 //The full scale pressure value, for example 120Kpa 传感器最大量程
#define DMIN 1677722.0 //AD value corresponding to The minimum range pressure,
// for example 10%AD=2^24*0.1 最低量程对应的 AD 值
#define DMAX 15099494.0 //AD Value Corresponding to The full scale pressure value,
// for example 90%AD=2^24*0.9 最高量程对应的 AD 值

sbit SCL = P3 ^ 3; //IIC clock line IIC 时钟线
sbit SDA = P1 ^ 5; //IIC data line IIC 数据线

//The 7-bit IIC address of the sensor is 0x78 传感器 7 位 IIC 总线地址
unsigned char Device_Address = 0x78 << 1;

float pressure_kpa = 0.0; //变量, 用于保存压力值, 单位为 KPa
unsigned long pressure_pa = 0; //变量, 用于保存压力值, 单位为 Pa
float temperature = 0.0; //变量, 用于保存温度值, 单位为 °C

void Delay_Ms(unsigned char n) //Ms Time-Delay function Ms 延时函数
{
    unsigned char i,j;
    for(i=0;i<n;i++)
        for(j=0;j<123;j++);
}

void Start(void) //Start signal IIC 总线起始信号
{
    SDA = 1;
    Delay_Ms(DELAY_TIME);
    SCL = 1;
    Delay_Ms(DELAY_TIME);
    SDA = 0;
```

```
    Delay_Ms(DELAY_TIME);
    SCL = 0;
    Delay_Ms(DELAY_TIME);
}

void Stop(void) //Stop signal IIC 总线停止信号
{
    SDA = 0;
    Delay_Ms(DELAY_TIME);
    SCL = 1;
    Delay_Ms(DELAY_TIME);
    SDA = 1;
    Delay_Ms(DELAY_TIME);
    SCL = 0;
    Delay_Ms(DELAY_TIME);
}

unsigned char Check_ACK(void) //Read sensor's ACK signal 读取传感器的 ACK 信号
{
    unsigned char ack;
    SDA = 1;
    Delay_Ms(DELAY_TIME);
    SCL = 1;
    Delay_Ms(DELAY_TIME / 2);
    ack = SDA;
    Delay_Ms(DELAY_TIME / 2);
    SCL = 0;
    Delay_Ms(DELAY_TIME);
    return ack;
}

void Send_ACK(void) //Send ACK signal to sensor 向传感器发送 ACK 信号
{
    SDA = 0;
    Delay_Ms(DELAY_TIME);
    SCL = 1;
    Delay_Ms(DELAY_TIME);
    SCL = 0;
    Delay_Ms(DELAY_TIME);
    SDA = 1;
    Delay_Ms(DELAY_TIME);
}
```

```
void SendByte(unsigned char byte1) //Send one byte to sensor 向传感器发送 1 个字节
{
    unsigned char i = 0;
    do
    {
        if (byte1 & 0x80)
        { SDA = 1; }
        else
        { SDA = 0; }
        Delay_Ms(DELAY_TIME);
        SCL = 1;
        Delay_Ms(DELAY_TIME);
        byte1 <<= 1;
        i++;
        SCL = 0;
    } while (i < 8);
    SCL = 0;
    Delay_Ms(DELAY_TIME);
}

unsigned char ReceiveByte(void) //Receive one byte from sensor 从传感器读取 1 个字节
{
    unsigned char i = 0, tmp = 0;
    do
    {
        tmp <<= 1;
        SCL = 1;
        Delay_Ms(DELAY_TIME);
        if (SDA)
        { tmp |= 1; }
        SCL = 0;
        Delay_Ms(DELAY_TIME);
        i++;
    } while (i < 8);
    return tmp;
}

//Write several bytes of data to the sensor 向传感器写若干个字节
unsigned char XGZP6830D_IIC_Write(unsigned char address, unsigned char *buf, unsigned char count)
{
    unsigned char timeout, ack;
```



```
address &= 0xFE; // The lowest bit of address is 0 means writing 地址值最低位为 0 表示写
Start();
Delay_Ms(DELAY_TIME);
SendByte(address); //Send the address to the sensor 向传感器发送地址值
Delay_Ms(DELAY_TIME);
timeout = 0;
do //Getting the ACK response from the sensor means success, otherwise means failure
{ //如能获取传感器的 ACK 信号, 则表示 IIC 总线通信成功; 则表示通信失败
    ack = Check_ACK();
    timeout++;
    if (timeout == 10)
    {
        Stop();
        return 1;
    }
} while (ack);
while (count)
{
    SendByte(*buf); //Write bytes to the sensor 向传感器写字节数据
    Delay_Ms(DELAY_TIME);
    timeout = 0;
    do
    {
        ack = Check_ACK();
        timeout++;
        if (timeout == 10)
        {
            return 2;
        }
    } while (0);
    buf++;
    count--;
}
Stop();
return 0;
}

//Read several bytes of data from the sensor 从传感器读取若干个字节
unsigned char XGZP6830D_IIC_Read(unsigned char address, unsigned char *buf, unsigned char count)
{
    unsigned char timeout, ack;
    address |= 0x01; // The lowest bit of address is 1 means reading 地址值最低位为 1 表示读
```

```
Start();
SendByte(address);
Delay_Ms(DELAY_TIME);
timeout = 0;
do //Getting the ACK response from the sensor means success, otherwise means failure
{ //如能获取传感器的 ACK 信号，则表示 IIC 总线通信成功；否则表示通信失败
    ack = Check_ACK();
    timeout++;
    if (timeout == 10)
    {
        Stop();
        return 1;
    }
} while (ack);
Delay_Ms(DELAY_TIME);
while (count)
{
    *buf = ReceiveByte();
    if (count != 1) //Except the last byte, send ACK to the sensor after receiving byte
        Send_ACK(); //除了最后一个字节外，每接收一个字节，向传感器发送 ACK 信号
    buf++;
    count--;
}
Stop();
return 0;
}

//Read the status of the sensor and judge whether IIC is busy
unsigned char XGZP6830D_IsBusy(void) //读取传感器的状态变量，用于判断数据是否已准备好被读取
{
    unsigned char status;
    XGZP6830D_IIC_Read(Device_Address, &status, 1);
    status = (status >> 5) & 0x01;
    return status;
}

void XGZP6830D_get_cal(void) //The function of reading pressure and temperature from the sensor
{
    //从传感器 XGZP6830D 读取压力值和温度值的函数
    unsigned char buffer[6] = {0}; //Temp variables used to restoring bytes from the sensor
    //临时变量，用于保存从传感器中读出的字节数据

    unsigned long Dtest = 0;
    unsigned int temp_raw = 0;
```

```

buffer[0] = 0xAC; //Send 0xAC command and read the returned six-byte data
XGZP6830D_IIC_Write(Device_Address, buffer, 1); //发送 0xAC 命令，启动一次压力和温度测量

Delay_Ms(DELAY_TIME);
while (1)
{
    if (XGZP6830D_IsBusy()) //判断传感器数据是否已准备好被读取
    {Delay_Ms(DELAY_TIME); }
    else
        break;
}
XGZP6830D_IIC_Read(Device_Address, buffer, 6); //读取传感器 6 个字节数据

//Computing the calibrated pressure and temperature values 计算校准后的压力值和温度值
Dtest = (unsigned long)((((unsigned long)buffer[1]) << 16) | (((unsigned int)buffer[2]) << 8) | ((unsigned char)buffer[3]));
temp_raw = ((unsigned int)buffer[4] << 8) | (buffer[5] << 0);

//The calibrated pressure value is converted into actual values
if (Dtest != 0)
{ //将校准后的压力值转换成真实的压力值
    pressure_kpa = (float) ((PMAX-PMIN)/(DMAX-DMIN)*(Dtest-DMIN)+PMIN); //单位: KPa
    pressure_pa = (unsigned long) (pressure_kpa * 1000.0); //单位: Pa
}
else
{
    pressure_kpa = 0.0; //pressure value, its unit is KPa 压力值, 单位: KPa
    pressure_pa = 0; //pressure value, its unit is Pa 压力值, 单位: Pa
}
temperature = (float) temp_raw / 65536; //The calibrated temperature value is converted into actual values
temperature = ((float) temp * 19000 - 4000) / 100; // its unit is °C
//将校准后的温度值转换成真实的温度值, 单位: °C
}

void main() //The main function
{
    Printf("CFSensor Ltd");
    while(1)
    {
        XGZP6830D_get_cal();
        Delay_Ms(1000);
        Printf("The pressure from XGZP6830D is %ld Pa\r\n", pressure_pa);
        Printf("The temperature from XGZP6830D is %f CTG\r\n\r\n", temperature);
    }
}
    
```

}
}